

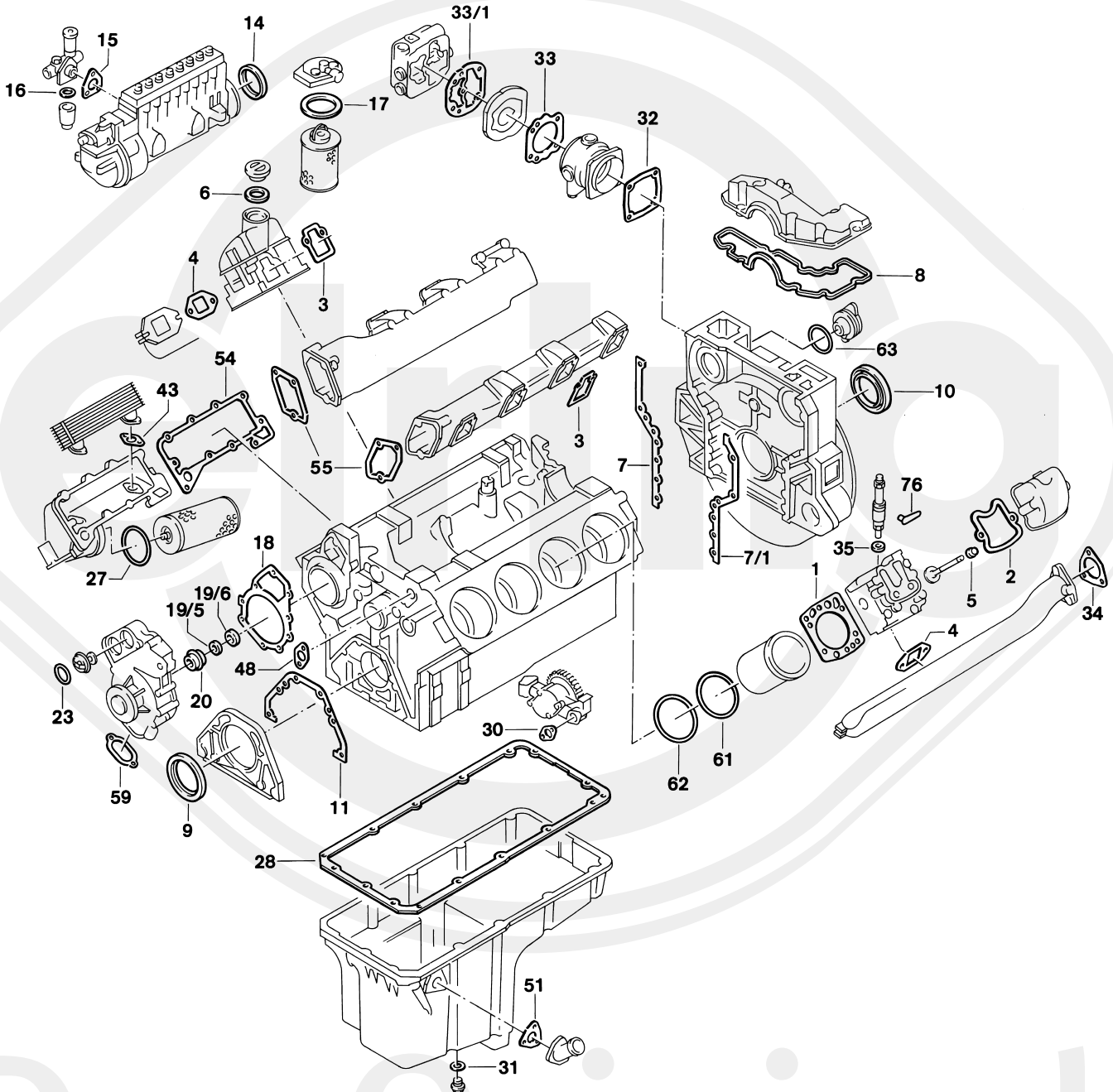

Das Original

Mercedes-Benz











OM 402



Das Original



402.900 | 905-907 | 910-914 | 916 | 917 | 919 | 921 | 923-928

			#	  	
S ⊕*	826.561	1x	-	-	 896.510 
ES	812.544	8x	444 010 01 20	-	 013688 →  896.510
ES	812.545	8x	444 010 01 20	-	 013688 →  412.180
ES ⊕	812.529	8x	-	-	 013688 →  748.080
ES ⊕	413.810	8x	-	-	 896.510  562.298
ES ⊕	570.282	8x	-	-	 896.510  391.190
CS *	812.579	1x	422 010 06 08	-	
ZLBS	827.533	8x	-	-	 Ø 143 mm
ZLBS	542.370	8x	-	-	 Ø 145,8 mm →  535118
ZLBS	542.380	8x	-	-	 Ø 145,8 mm incl. 703.214  535119 →
WPS	812.617	1x	422 200 09 01	-	 257476 Ø 15 mm
SZ	812.552	1x	423 010 48 33	-	
LPS	061.460	1x	402 130 02 20	-	-
LPS	127.550	1x	-	-	-
ZKS	820.091	8x	-	M15x2x109 M15x2x144 M15x2x168	 129661 →
1	748.080	8x	422 016 06 20	Ø 143,5 mm $\frac{\text{---}}{\text{---}}$ 1,23 mm	-
1	748.110	8x	422 016 07 20	Ø 143,5 mm $\frac{\text{---}}{\text{---}}$ 1,33 mm 2 ▽	-
1	896.510	8x	442 016 03 20	Ø 143,5 mm $\frac{\text{---}}{\text{---}}$ 1,25 mm	galvanized/verzinkt
1	412.180	8x	442 016 04 20	Ø 143,5 mm $\frac{\text{---}}{\text{---}}$ 1,25 mm	stainless steel/Edelstahl
2	193.640	8x	403 016 01 21	-	→  013687
2	977.438	8x	442 016 06 21	-	 013688 →
3	896.365	8x	442 141 17 80	-	-
4	225.126	8x	403 142 03 80	-	-
5	562.298	16x	422 053 01 96	12x15,7/20x15 FPM	-
5	391.190	16x	403 053 01 96	12x15,7/20x15 AEM	-



402.900 | 905-907 | 910-914 | 916 | 917 | 919 | 921 | 923-928

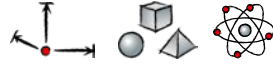

6		1x	352 018 01 80	37x59,5x3 CP	-
7	819.191	1x	442 015 01 80	-	-
7/1	819.205	1x	442 015 00 80	-	-
8	759.139	1x	442 015 00 60	-	-
9	524.973	1x	014 997 46 47	105x130x12 AW/BS RD FPM	476.070
9	766.853	1x	-	105x130x12 AW/BS RD PTFE/ACM	476.070
9	369.901	1x	025 997 39 47	100x130x11 ASW RD PTFE/ACM	-
10	562.920	1x	013 997 14 47	120x140x13 AW/BS LD FPM	834.289
10	766.829	1x	-	120x140x13 AW/BS LD PTFE/ACM	834.289
10	354.090	1x	025 997 50 47	115x140x12 ASW LD PTFE/ACM	-
11	756.769	1x	442 011 00 80	-	-
14	759.147	1x	442 074 00 59	94,5x105,3x9 ACM PR	-
15		1x	001 074 22 80	-	-
16	716.200	1x	000 997 00 40	28x36x2 NBR A	-
17	731.269	2x	000 477 35 80	75x81,4x3 NBR A	→ 252381
17	733.431	1x	000 477 31 80	95x103x3 NBR A	252382 →
18	775.984	1x	442 201 10 80	-	→ 129660
18	756.882	1x	442 201 00 80	-	129661 →
19/5	-	1x	000 201 04 63	-	Ø 16 mm
19/6	-	1x	000 201 01 97	-	Ø 16 mm
20	-	1x	000 201 72 19	-	→ 257475 Ø 16 mm
20	577.804	1x	001 201 19 19	-	257476 → Ø 15 mm
23	495.980	2x	024 997 28 48	58x67x4,3 EPDM PR	-
27	780.103	1x	008 997 70 45	134x4 NBR RD	-
28	765.718	1x	442 014 02 22	-	
30	759.300	1x	917003 036003	-	-
31	031.046	1x	007603 026109	26x34x2 CU A	-
32	374.690	1x	442 131 27 80	-	-



402.900 | 905-907 | 910-914 | 916 | 917 | 919 | 921 | 923-928

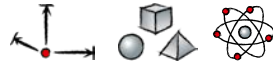

33	775.790	1x	442 131 09 80	-	-
33/1	775.819	1x	442 131 07 80	-	-
34	778.061	2x	442 492 00 80	-	-
35	106.909	8x	346 017 01 60	9,5x20x1 CU A	-
35	067.989	8x	346 017 02 60	9,5x20x1,5 CU A	-
43	759.296	2x	917003 026003	-	-
51	756.785	1x	442 018 00 80	-	-
54	776.000	1x	442 184 05 80	-	->  129660
54	765.735	1x	442 188 05 80	-	 129661 ->
55	756.830	2x	442 141 07 80	-	-
59	768.392	1x	442 201 04 80	-	
59	463.250	1x	000 201 10 80	-	
59	680.271	1x	000 201 12 80	-	
61	825.786	8x	009 997 88 48	138x1,9 FPM RD	 Ø 143 mm
61	538.120	16x	025 997 84 48	140x1,9 FPM RD	 Ø 145,8 mm ->  535118
61	538.120	8x	025 997 84 48	140x1,9 FP RD	 Ø 145,8 mm  535119 ->
61/1	703.214	8x	442 011 00 59	147,4x153,5x0,15 A	 535119 ->
61/1	863.020	8x	-	147,4x153,5x0,25 A	 535119 ->
61/1	896.455	8x	442 011 02 59	147,4x153,5x0,50 A	 535119 ->
62	825.794	16x	012 997 71 48	140x3,8 FPM RD	 Ø 143 mm
62	538.090	16x	025 997 85 48	144x3,8 FPM RD	 Ø 145,8 mm
63	102.032	1x	014 997 61 48	78x3 NBR RD	-
76	558.060	8x	403 016 00 61	-	-